

 **vogelsitze**[®]



Strada

Strada
M1



Strada

Der Einzelsitz für alle gängigen Minibusse

- Prüfung der Festigkeit der Verankerungspunkte für Sicherheitsgurte gemäß ECE R 16 sowie 76/115/EWG für Fahrzeuge der Klasse M1.
- Prüfung der Sitze, Ihrer Verankerungen und Kopfstützen gemäß 74/408/EWG für Fahrzeuge der Klasse M1.
- Zulassung der Isofix Verankerung gemäß ECE R 14 für Fahrzeuge der Klasse M1.

The Single Seat for all current Mini Buses

- Tests on the stability of the fixing points for the seatbelts in accordance with ECE R 16 and 76/115/EEC for M1 class vehicles.
- Tests on seats, their fixings and headrests in accordance with 74/408/EEC for M1 class vehicles.
- Isofix approved according ECE R 14 for M1 class vehicles.

Le siège individuel pour tous les minibus du marché

- Contrôle de la résistance des points d'ancrage pour les ceintures de sécurité conformément à la norme ECE R 16 ainsi que 76/115/CEE pour les véhicules de la catégorie M1.
- Contrôle des sièges, de leurs ancrages et des appuie-têtes conformément à 74/408/CEE pour les véhicules de la catégorie M1.
- Isofix ECE R 14 pour les véhicules de la catégorie M1.

El asiento individual para todos los Minibús corrientes

- Prueba de resistencia de los puntos de anclaje de los cinturones de seguridad según ECE R 16 y 76/115/CEE para vehículos de la clase M1.
- Prueba de los asientos, de sus anclajes y reposacabezas según 74/408/ CEE para vehículos de la clase M1.
- Isofix ECE R 14 para vehículos de la clase M1.



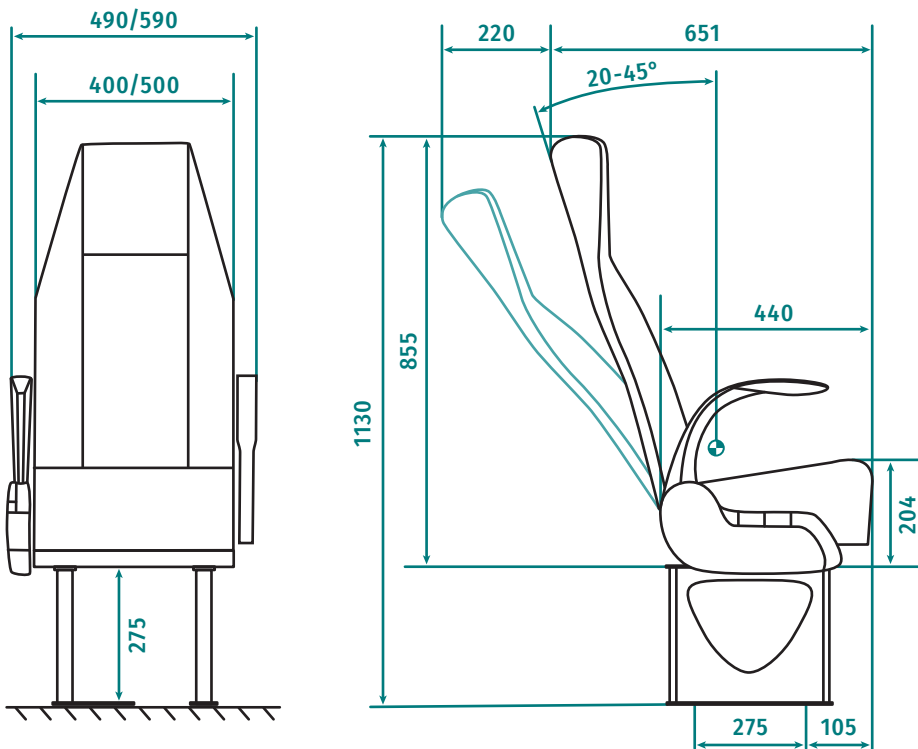

 Hochfest
Fix back rest
Dossier fixe
Respaldo fijo

 Rückwärtsverstellung
Seat back reclining mechanism
Inclinaison du dossier
Ajuste hacia atras

 3 Punktgurtsystem
3 point belt
Ceintures 3 points
Cinturones 3 Puntos

 ISOFIX ISOFIX - Kindersitzbefestigung
ISOFIX - child seat fastening
ISOFIX - fixation pour siège enfant
ISOFIX - fijación del asiento del niño

Bogengriff
Grab handle
Poignée
Asidero



Klapptisch
Tray table
Tablette
Mesa



Zeitungsnetz
Document net
Porte document
Revistero



Absenkbare Armlehne
Fold-down armrest
Accoudoir escamotable
Apoyabrazos abatible



Winkelabdeckung
Seat angle cover
Cache latéral
Ángulo de cobertura

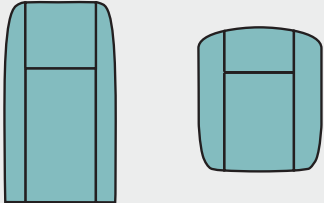
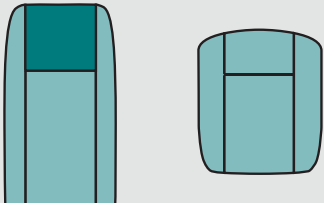
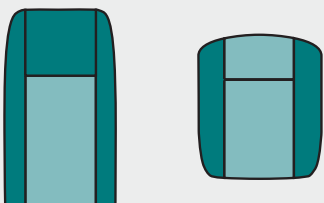
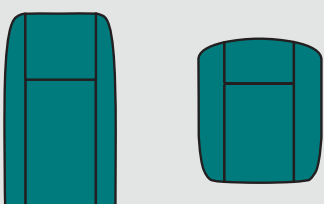

optionale Polsterung | optional upholstery | garnissage optionnel | acolchado opcional

Darstellung graph	Bezeichnung designation	Beschreibung description	Option option
	Standard	Ausführung in Stoff <i>fabric design</i>	<ul style="list-style-type: none"> • Keder <i>pipng</i> • Doppelsteppnaht <i>double quilting seam</i>
	Plus	Zusätzlich abgesetzter Kopfeinsatz <i>Additional contrasting headrest insert</i>	<ul style="list-style-type: none"> • Ambassador: hochwertige Doppelpolsterung <i>Additional Ambassador upholstery</i>
	Prestige	Zusätzlich abgesetzter Kopfeinsatz und Seitenteile <i>Additional contrasting headrest insert and side parts</i>	<ul style="list-style-type: none"> • Deluxe: zusätzlich 10 mm Schaumpolsterung <i>Additional Deluxe 10 mm upholstery</i>
	Executive	Ausführung in Vollleder <i>leather design</i>	

Kontakt | contact | contacter | contacto

Vogelsitze GmbH

Kleinsteinbacher Straße 44
D-76228 Karlsruhe
Germany

Phone | Telefon: +49 721 4702 0
Fax | Telefax: +49 721 4702 2500
E-Mail: info@vogelsitze.com